

THE NEW VALUE FRONTIER



Solid End Mill

4MFK/4MFR

High Efficiency End Mill for Steel Machining

4MFK/4MFR

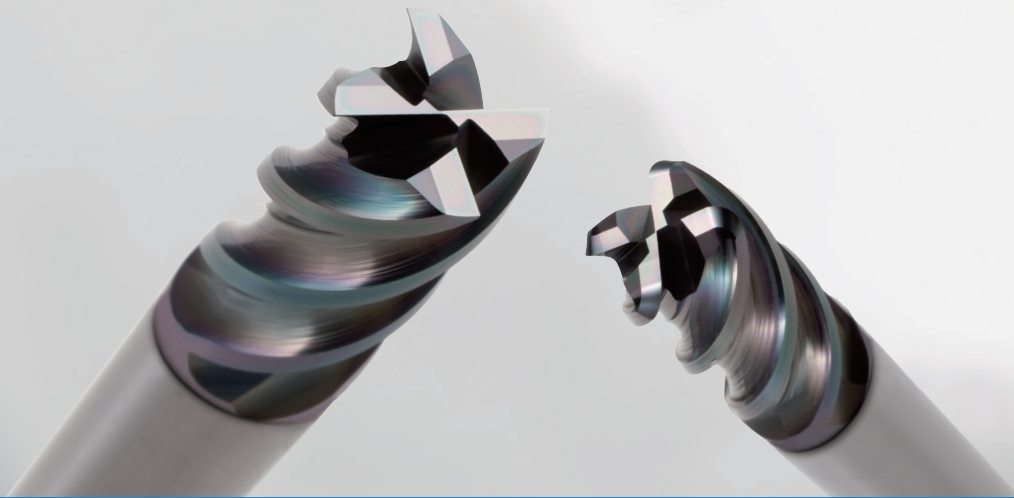

Resists Chattering for Stable, High Feed Machining of Steel

Chatter Resistant with Unique Variable Helix Design

Good Chip Evacuation

Square End Type (4MFK) and Corner Radius Type (4MFR) are Available

Lineup Expansion

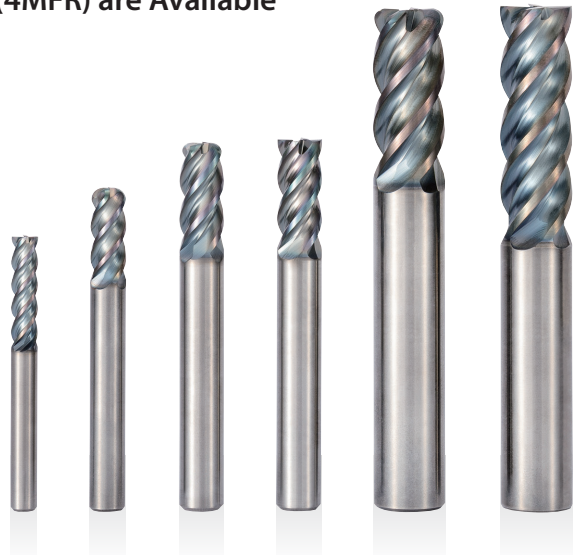

High Efficiency End Mill for Steel Machining

4MFK/4MFR

Good for High Feed Machining of Steel

High Efficiency with Unique Variable Helix Design

1 Chatter Resistant Variable Helix Design

Excellent Surface Finish with Reduced Chattering

Unequal Spacing of Teeth

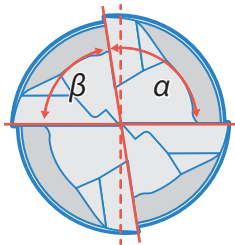

Cutting force distribution varies due to variable flute width, which prevents periodical vibration during machining

$$\alpha \neq \beta$$

Variable Helix

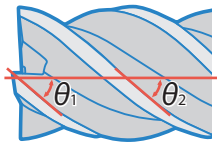

Each flute contains optimized helix angle (lead angle θ), which prevents vibration and achieves a clean surface finish

$$\theta_1 \neq \theta_2$$

Cutting Force Comparison
(In-house Evaluation)

Drastically Reduced Vibration for Stable Machining

4MFK

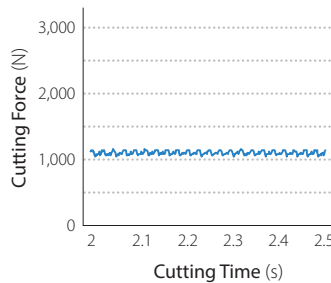

Competitor A

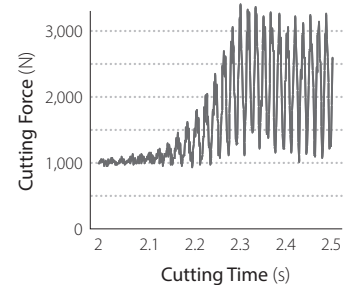

Cutting Conditions: $n = 2,650 \text{ min}^{-1}$, $V_f = 300 \text{ mm/min}$, $a_p \times a_e = 10 \times 8 \text{ mm}$, Cutter Dia. $\phi 8$, Slotting Wet Workpiece: SCM440

Surface Comparison
(In-house Evaluation)

4MFK



Competitor A



Chattering

Cutting Conditions: $n = 6,000 \text{ min}^{-1}$, $V_f = 1,500 \text{ mm/min}$, $a_p \times a_e = 8 \times 2 \text{ mm}$, Cutter Dia. $\phi 8$, Shouldering Wet Workpiece: S45C

2 Good Chip Evacuation

Unique Flute Design for Smooth Chip Evacuation Even in Slotting and High Feed Machining Applications

Wide Chip Pocket

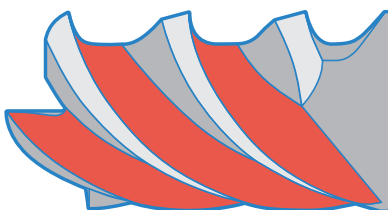

Core Thickness Comparison

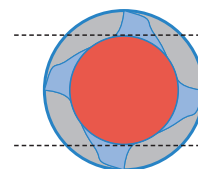

4MFK/4MFR

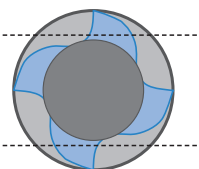

Conventional

3 Achieves Long Tool Life and Stable Machining

Special Nano-layer Coating MEGACOAT NANO controls wear progress and improves chipping resistance

Coating Properties (Abrasion Resistance)

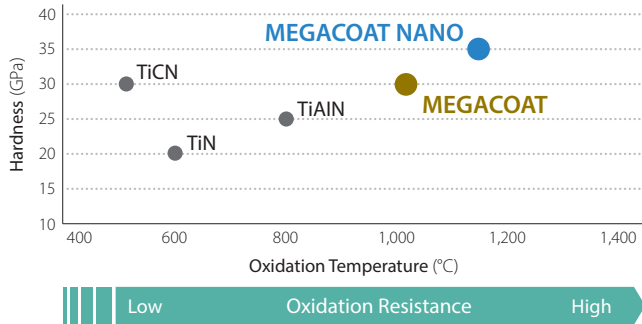

Coating Properties (Deposition Resistance)

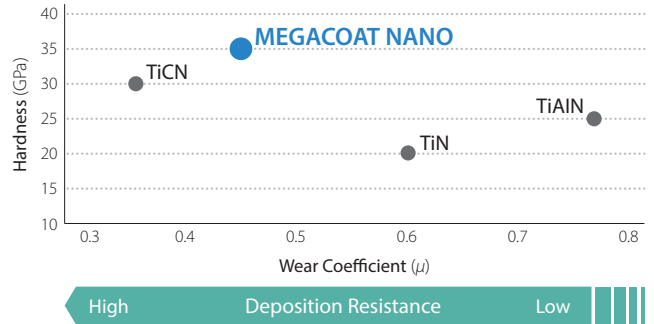

Achieve long tool life with the combination of a tough substrate and a special Nano coating layer

Stable Machining with Excellent Wear Resistance

Abrasion Resistance Comparison

(In-house Evaluation)

4MFK

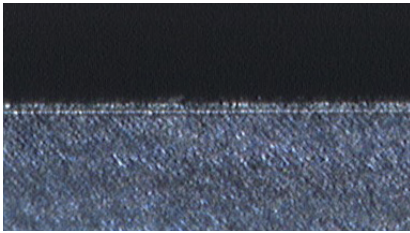

Competitor B

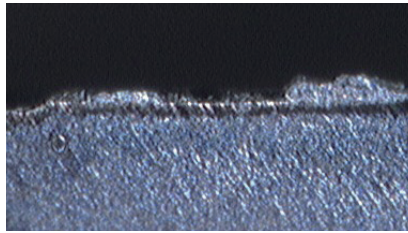

Competitor C

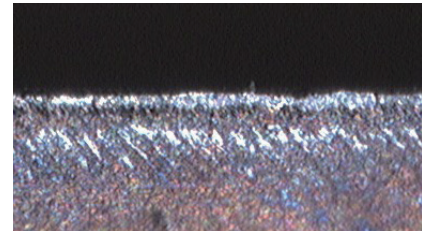

Edge Conditions after 140m Cutting

Cutting Conditions: $n = 6,000 \text{ min}^{-1}$, $V_f = 1,100 \text{ mm/min}$, $ap \times ae = 5.0 \times 0.8 \text{ mm}$, Cutter Dia. $\varnothing 8$, Shouldering, Wet Workpiece: SCM440

4 High Quality Sharp Edge

High Quality Sharp Edge with Advanced Grinding Technology Enables Excellent Surface Finish

4MFR Corner Radius Type

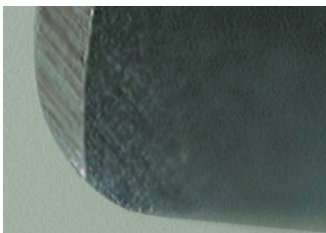

Smooth and Sharp Cutting Edge Up to the Tip **Preventing Burrs**

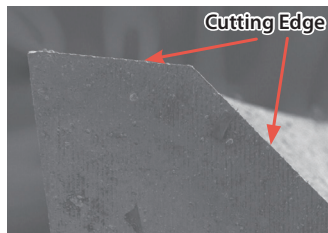

4MFK

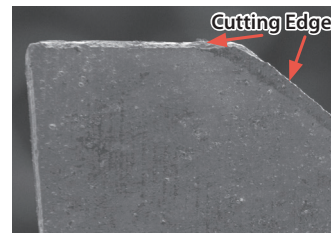

Competitor D

4MFK (Square Type)

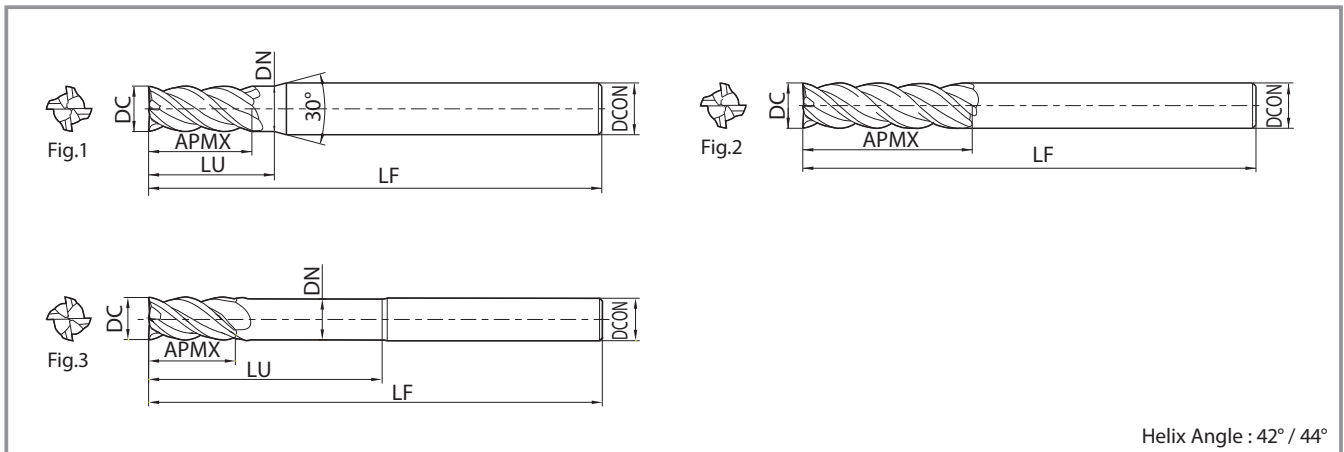

(Unit : mm)

Description	Stock	Cutter Dia.	Outside Dia. Tolerance	Length of cut	Flute Length*	Neck Dia.	Under Neck Length	Shank Dia.	Overall Length	Number of Flutes	Shape
		DC		APMX	Type	DN	LU	DCON	LF	ZEFP	
4MFK030-045	●	3.0	0 -0.015	4.5	S	3.15	5.4	6	60	4	Fig.1
4MFK030-080	●			8	M		9.6				
4MFK030-120	●			12	L		14.4				
4MFK035-050	●	3.5	0 -0.015	5	S	3.7	6.0	6	60	4	
4MFK035-095	●			9.5	M		11.4				
4MFK035-140	●			14	L		16.8				
4MFK040-060	●	4.0	0 -0.015	6	S	4.2	7.2	6	60	4	
4MFK040-110	●			11	M		13.2				
4MFK040-120	●			12	M (3D)		14.4				
4MFK040-160	●			16	L		19.2				
4MFK045-065	●	4.5	0 -0.015	6.5	S	4.7	7.8	6	60	4	
4MFK045-120	●			12	M		14.4				
4MFK045-180	●			18	L		21.6				
4MFK050-075	●	5.0	0 -0.015	7.5	S	5.2	9.0	6	60	4	
4MFK050-130	●			13	M		15.6				
4MFK050-200	●			20	L		24.0				
4MFK055-080	●	5.5	0 -0.015	8	S	5.7	9.6	6	60	4	
4MFK055-130	●			13	M		15.6				
4MFK055-210	●			21	L		25.2				
4MFK060-090	●	6.0	0 -0.020	9	S	-	-	6	60	4	Fig.2
NEW 4MFK060-090-180	●			9	S-L	5.8	18.0	6	60	4	Fig.3
NEW 4MFK060-090-300	●			9	S-L	5.8	30.0	6	70	4	Fig.3
4MFK060-130	●			13	M	-	-	6	60	4	Fig.2
4MFK060-150	●			15	M (2.5D)	-	-	6	60	4	Fig.2
4MFK060-220	●			22	L	-	-	6	60	4	Fig.2
NEW 4MFK065-160	●	6.5	0 -0.020	16	M	6.7	19.2	8	70	4	Fig.1
4MFK070-105	●	7.0	0 -0.020	10.5	S	7.2	12.6	8	70	4	
4MFK070-160	●			16	M		19.2				
4MFK070-250	●			25	L		30.0				
NEW 4MFK075-190	●	7.5	0 -0.020	19	M	7.7	22.8	8	70	4	Fig.2
4MFK080-120	●	8.0	-0.005 -0.025	12	S	-	-	8	70	4	
NEW 4MFK080-120-240	●			12	S-L	7.7	24.0	8	70	4	Fig.3
NEW 4MFK080-120-400	●			12	S-L	7.7	40.0	8	80	4	
4MFK080-190	●			19	M	-	-	8	70	4	Fig.2
4MFK080-200	●	20	M (2.5D)	-	-	8	70	4	Fig.2		
4MFK080-280	●	28	L	-	-	8	70	4	Fig.2		
NEW 4MFK085-190	●	8.5	-0.005 -0.025	19	M	8.7	22.8	10	80	4	Fig.1
4MFK090-135	●	9.0	-0.005 -0.025	13.5	S	9.2	16.2				
4MFK090-205	●			20.5	M		24.6				

*Flute Length Type : S (Short), S - L (Short / Long Shank), M (Medium), L (Long)

● : Standard Stock

4MFK (Square Type)

(Unit : mm)

Description	Stock	Cutter Dia.	Outside Dia. Tolerance	Length of cut	Flute Length* Type	Neck Dia.	Under Neck Length	Shank Dia.	Overall Length	Number of Flutes	Shape
		DC		APMX		DN	LU	DCON	LF	ZEPF	
NEW 4MFK095-220	●	9.5	-0.005 -0.025	22	M	9.7	26.4	10	80	4	Fig.1
4MFK100-150	●	10.0	-0.005 -0.025	15	S	-	-	10	80	4	Fig.2
NEW 4MFK100-150-300	●				S-L	9.7	30.0		Fig.3		
NEW 4MFK100-150-500	●				S-L	50.0					
4MFK100-220	●			22	M	-	-	80	Fig.2		
4MFK100-250	●			25	M (2.5D)	-	-				
4MFK100-330	●			33	L	-	-				
NEW 4MFK110-260	●	11.0	-0.010 -0.030	26	M	11.2	31.2	12	100	4	Fig.1
4MFK120-180	●	12.0	-0.010 -0.030	18	S	-	-	12	100	4	Fig.2
NEW 4MFK120-180-360	●				S-L	11.7	36.0		Fig.3		
NEW 4MFK120-180-600	●				S-L	60.0					
4MFK120-260	●			26	M	-	-	100	Fig.2		
4MFK120-360	●			36	L	-	-				
4MFK160-240	●			24	S	-	-				
4MFK160-350	●	16.0	-0.010 -0.030	35	M	-	-	16	110	4	Fig.2
4MFK160-480	●			48	L	-	-				

*Flute Length Type : S (Short), S - L (Short / Long Shank), M (Medium), L (Long)

● : Standard Stock

Case Studies

Automotive Parts S45C

$n = 3,500 \text{ min}^{-1}$ ($V_c = 77 \text{ m/min}$)
 $V_f = 1,000 \text{ mm/min}$
 $(f_z = 0.071 \text{ mm/t})$
 $ap \times ae = 5 \times 7 \text{ mm}$, Wet
 4MFK070-160

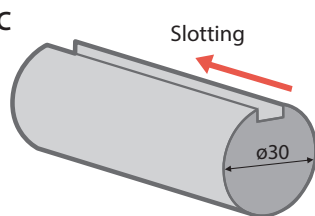

Tool Life

4MFK070-160

255 pcs/edge

Tool Life **Efficiency**
 ↑ **5 Times** ↑ **6.6 Times**

Competitor E

50 pcs/edge

(Competitor E Cutting Conditions)
 $\phi 7 \cdot 4$ Flutes $n = 2,000 \text{ min}^{-1}$ ($V_c = 44 \text{ m/min}$)
 $V_f = 150 \text{ mm/min}$ ($f_z = 0.019 \text{ mm/t}$), $ap \times ae = 5 \times 7 \text{ mm}$, Wet

Kyocera showed 5 times longer tool life than Competitor E.
 Compared to Competitor E, Kyocera increased the feed rate by 6.6 times.
 No vibration occurred. Stable milling.

(User Evaluation)

Machine Parts SCr415

$n = 1,400 \text{ min}^{-1}$ ($V_c = 53 \text{ m/min}$)
 $V_f = 280 \text{ mm/min}$ ($f_z = 0.05 \text{ mm/t}$)
 $ap \times ae = 12 \times 5 \text{ mm}$, Wet
 4MFK120-260

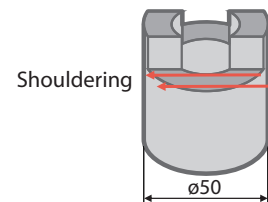

Tool Life

4MFK120-260

700 pcs/edge and more

Tool Life
 ↑ **3.5 Times**

Competitor F

200 pcs/edge

(Competitor F Cutting Conditions)
 $\phi 12 \cdot 4$ Flutes $n = 1,400 \text{ min}^{-1}$ ($V_c = 53 \text{ m/min}$)
 $V_f = 280 \text{ mm/min}$ ($f_z = 0.05 \text{ mm/t}$), $ap \times ae = 12 \times 5 \text{ mm}$, Wet

Reduced load on the tool, even after cutting 700 pieces. Regular cutting sounds,
 no chattering

(User Evaluation)

Automotive Parts SCM415H

$n = 5,300 \text{ min}^{-1}$ ($V_c = 100 \text{ m/min}$)
 $V_f = 500 \text{ mm/min}$ (0.09 mm/t)
 $ap \times ae = 3.5 \times 0.9 \text{ mm}$, Wet
 4MFR060-130-R10

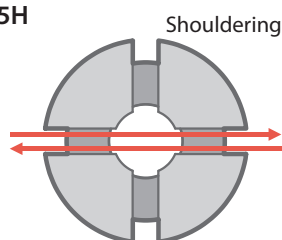

Tool Life

4MFR060-130-R10

1,000 pcs/edge

Tool Life
 ↑ **2 Times**

Competitor G

500 pcs/edge

The 4MFR End Mill machined 1,000 pieces and was available for further cutting,
 while Competitor G could not continue cutting because of chipping after
 processing 500 pieces.

(User Evaluation)

4MFR (Radius)

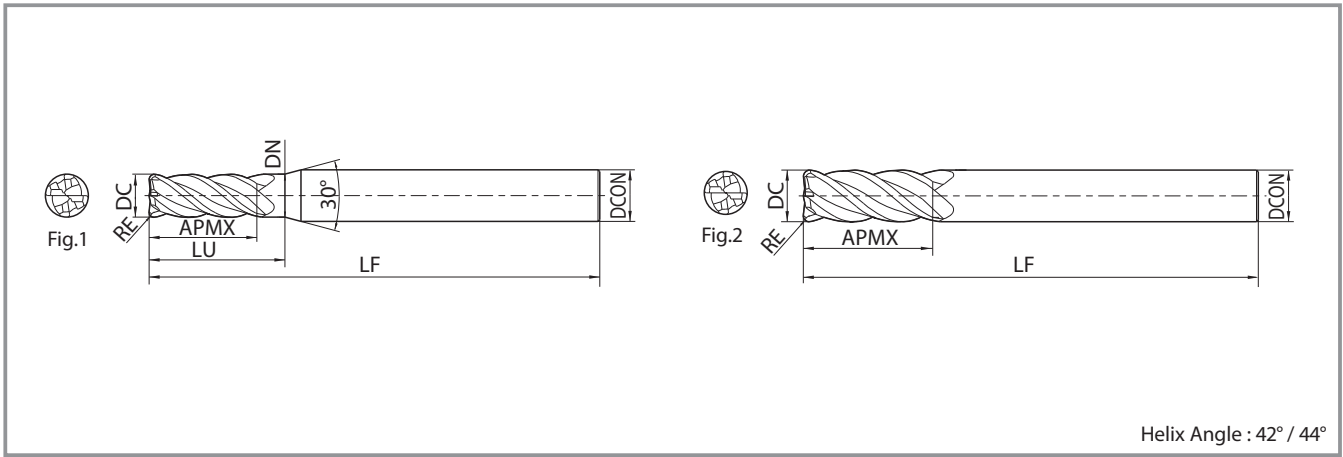

(Unit : mm)

Description	Stock	Cutter Dia.	Outside Dia.	Corner R	Length of cut	Neck Dia.	Under Neck Length	Shank Dia.	Overall Length	Number of Flutes	Shape			
		DC	Tolerance	RE	APMX	DN	LU	DCON	LF	ZEFP				
4MFR030-080-R02	●	3.0	0 -0.015	0.2	8	3.15	9.6	6	60	4	Fig.1			
4MFR030-080-R03	●			0.3										
4MFR030-080-R05	●			0.5										
4MFR035-095-R02	●	3.5	0 -0.015	0.2	9.5	3.7	11.4	6	60	4		Fig.1		
4MFR035-095-R03	●			0.3										
4MFR035-095-R05	●			0.5										
4MFR040-110-R02	●	4.0	0 -0.015	0.2	11	4.2	13.2	6	60	4			Fig.1	
4MFR040-110-R03	●			0.3										
4MFR040-110-R05	●			0.5										
4MFR040-110-R10	●			1.0										
4MFR045-120-R02	●	4.5	0 -0.015	0.2	12	4.7	14.4	6	60	4				Fig.1
4MFR045-120-R03	●			0.3										
4MFR045-120-R05	●			0.5										
4MFR045-120-R10	●			1.0										
4MFR050-130-R02	●	5.0	0 -0.015	0.2	13	5.2	15.6	6	60	4	Fig.1			
4MFR050-130-R03	●			0.3										
4MFR050-130-R05	●			0.5										
4MFR050-130-R10	●			1.0										
NEW 4MFR055-130-R02	●	5.5	0 -0.015	0.2	13	5.7	15.6	6	60	4		Fig.1		
4MFR055-130-R03	●			0.3										
4MFR055-130-R05	●			0.5										
4MFR055-130-R10	●			1.0										
NEW 4MFR060-130-R02	●	6.0	0 -0.020	0.2	13	-	-	6	60	4			Fig.2	
4MFR060-130-R03	●			0.3										
4MFR060-130-R05	●			0.5										
4MFR060-130-R10	●			1.0										
4MFR060-130-R15	●			1.5										
NEW 4MFR080-190-R02	●	8.0	-0.005 -0.025	0.2	19	-	-	8	70	4	Fig.2			
4MFR080-190-R03	●			0.3										
4MFR080-190-R05	●			0.5										
4MFR080-190-R10	●			1.0										
4MFR080-190-R15	●			1.5										
4MFR080-190-R20	●			2.0										
4MFR080-190-R30	●			3.0										
NEW 4MFR100-220-R02	●	10.0	-0.005 -0.025	0.2	22	-	-	10	80	4		Fig.2		
4MFR100-220-R03	●			0.3										
4MFR100-220-R05	●			0.5										
4MFR100-220-R10	●			1.0										
4MFR100-220-R15	●			1.5										
4MFR100-220-R20	●			2.0										
4MFR100-220-R30	●			3.0										

● : Standard Stock

4MFR (Radius)

(Unit : mm)

Description	Stock	Cutter Dia.	Outside Dia. Tolerance	Corner R	Length of cut	Neck Dia.	Under Neck Length	Shank Dia.	Overall Length	Number of Flutes	Shape
		DC		RE							
NEW 4MFR120-260-R03	●	12.0	-0.010 -0.030	0.3	26	-	-	12	100	4	Fig.2
4MFR120-260-R05	●			0.5							
4MFR120-260-R10	●			1.0							
4MFR120-260-R15	●			1.5							
4MFR120-260-R20	●			2.0							
4MFR120-260-R30	●			3.0							
4MFR160-350-R10	●	16.0	-0.010 -0.030	1.0	35	-	-	16	110	4	
4MFR160-350-R15	●			1.5							
4MFR160-350-R20	●			2.0							
4MFR160-350-R30	●			3.0							
	●										

● : Standard Stock

Cutting Conditions

4MFK (Short · Medium) / 4MFR

Workpiece Material	Application	Depth of Cut $ap \times ae$ (mm)	Cutter Dia. DC (mm)	$\phi 3$	$\phi 4$	$\phi 5$	$\phi 6$	$\phi 8$	$\phi 10$	$\phi 12$	$\phi 16$
Carbon Steel S45C	Shouldering	Short 1.2DC \times 0.15DC Medium 1.5DC \times 0.15DC	Number of Revolutions (min^{-1})	13,800	10,700	8,800	7,500	6,000	4,800	4,000	3,300
			Feed Rate (mm/min)	1,400	1,400	1,400	1,500	1,500	1,400	1,400	1,300
	Slotting	$ap \leq 1.0DC$	Number of Revolutions (min^{-1})	13,800	10,700	8,800	7,500	6,000	4,800	4,000	3,300
			Feed Rate (mm/min)	620	700	750	780	830	850	800	750
Alloy Steel SCM, SNCM	Shouldering	Short 1.2DC \times 0.1DC Medium 1.5DC \times 0.1DC	Number of Revolutions (min^{-1})	10,600	9,300	8,300	7,400	6,000	4,700	3,800	2,800
			Feed Rate (mm/min)	1,000	1,000	1,000	1,100	1,100	1,000	1,000	900
	Slotting	$ap \leq 1.0DC$	Number of Revolutions (min^{-1})	10,600	9,300	8,300	7,400	6,000	4,700	3,800	2,800
			Feed Rate (mm/min)	500	510	520	530	550	570	530	450
Pre-hardened Steel (30 ~ 45HRC)	Shouldering	Short 1.2DC \times 0.07DC Medium 1.5DC \times 0.07DC	Number of Revolutions (min^{-1})	8,700	6,800	5,500	4,600	3,500	2,800	2,300	1,700
			Feed Rate (mm/min)	670	730	790	840	900	810	770	630
	Slotting	$ap \leq 1.0DC$	Number of Revolutions (min^{-1})	6,700	5,800	4,800	4,000	3,000	2,300	1,900	1,400
			Feed Rate (mm/min)	320	330	360	370	400	420	380	300
Stainless Steel SUS304	Shouldering	Short 1.2DC \times 0.1DC Medium 1.5DC \times 0.1DC	Number of Revolutions (min^{-1})	8,700	7,000	6,000	5,200	4,000	3,000	2,500	1,700
			Feed Rate (mm/min)	670	720	780	830	840	760	710	520
	Slotting	$ap \leq 0.3DC$	Number of Revolutions (min^{-1})	6,800	6,000	5,100	4,300	3,400	2,600	2,000	1,400
			Feed Rate (mm/min)	190	220	240	250	250	240	230	190
Titanium Alloy	Shouldering	Short 1.2DC \times 0.1DC Medium 1.5DC \times 0.1DC	Number of Revolutions (min^{-1})	8,700	7,000	6,000	5,200	4,000	3,000	2,500	1,700
			Feed Rate (mm/min)	670	720	780	830	840	760	710	520
	Slotting	$ap \leq 0.3DC$	Number of Revolutions (min^{-1})	6,800	6,000	5,100	4,300	3,400	2,600	2,000	1,400
			Feed Rate (mm/min)	190	220	240	250	250	240	230	190

Cutting with coolant is recommended for stainless steel, titanium alloy and heat-resistant alloy.

Cutting Conditions

4MFK (Short / Long Shank · Long)

Workpiece Material	Application	Depth of Cut $ap \times ae$ (mm)	Cutter Dia. DC (mm)	ø 3	ø 4	ø 5	ø 6	ø 8	ø 10	ø 12	ø 16
Carbon Steel S45C	Shouldering	3DC × 0.02DC	Number of Revolutions (min ⁻¹)	11,000	8,500	7,000	6,000	4,800	3,800	3,200	2,600
			Feed Rate (mm/min)	910	910	910	970	970	910	910	840
Alloy Steel SCM, SNCM			Number of Revolutions (min ⁻¹)	6,500	5,700	5,100	4,500	3,700	2,900	2,300	1,700
			Feed Rate (mm/min)	540	540	540	600	600	540	540	490
Pre-hardened Steel (30 ~ 45HRC)			Number of Revolutions (min ⁻¹)	4,900	3,900	3,100	2,600	2,000	1,600	1,300	1,000
			Feed Rate (mm/min)	330	360	400	420	450	400	380	310
Stainless Steel SUS304			Number of Revolutions (min ⁻¹)	4,300	3,500	3,000	2,600	2,000	1,500	1,300	900
			Feed Rate (mm/min)	330	360	390	410	420	380	350	260
Titanium Alloy			Number of Revolutions (min ⁻¹)	4,300	3,500	3,000	2,600	2,000	1,500	1,300	900
			Feed Rate (mm/min)	330	360	390	410	420	380	350	260

Cutting with coolant is recommended for stainless steel, titanium alloy and heat-resistant alloy.

Slotting is not recommended

Application

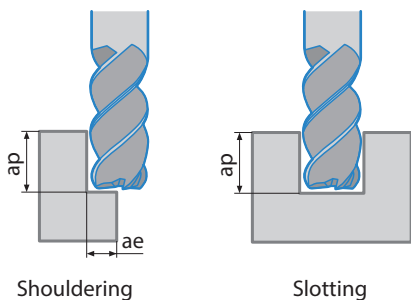

Cutting with compressed air or coolant is recommended
 Cutting with coolant is recommended for stainless steel and titanium alloy
 Adjust ap to according to machine's rigidity
 Use a chuck and a machine with as high a rigidity as possible