

THE NEW VALUE FRONTIER



High-Precision
Small Internal Grooving | **SIGC**

High-Precision Small Internal Grooving

SIGC **NEW**

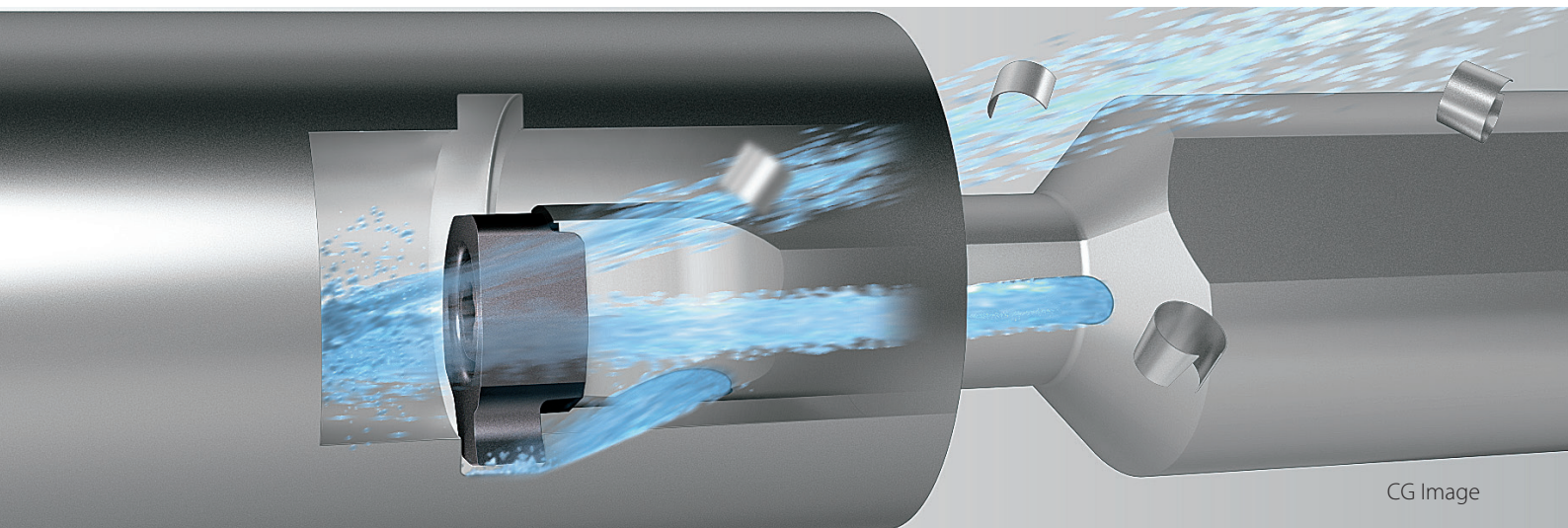

High-Precision Small Internal Grooving with a $\varnothing 8$ mm Minimum Cutting Diameter

Newly Developed Clamping System Ensures a Firm Insert Hold to Provide High-Precision Machining

Excellent Chip Evacuation with Double Coolant Holes

Long Tool Life with MEGACOAT NANO PLUS "PR1725"

Minimum Cutting Diameter $\varnothing 8$ mm

Excellent Bars and Carbide Shank Bars
Added to the Lineup



High-Precision Small Internal Grooving

SIGC

Newly Developed Clamping System Ensures a Firm Insert Hold to Provide High-Precision Machining. Excellent Chip Evacuation with Double Coolant Holes and Optimized Flute Shape with a $\varnothing 8\text{mm}$ Minimum Cutting Diameter

1 Firm Insert Clamping System Provides High-Precision Machining

Firm clamping action by pulling the bottom surface of the insert in axial direction

Stable machining is achieved by ensuring a firm clamp on the insert

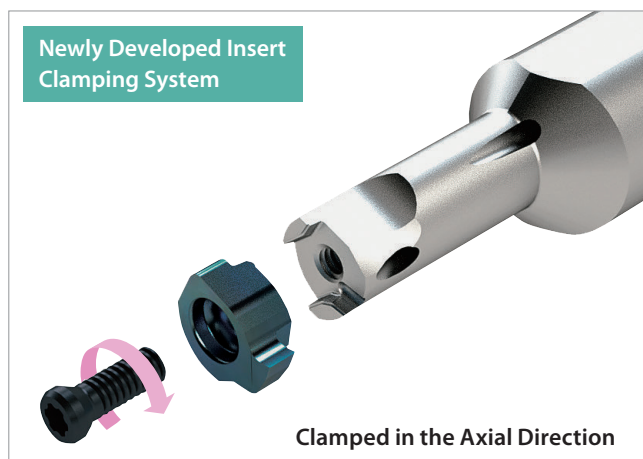

Clamping Part (image)

Firm clamping is available due to large contact surface

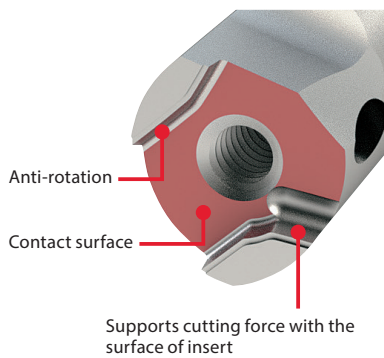

SIGC

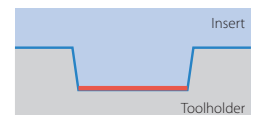

Bottom Surface Contact

Competitor A

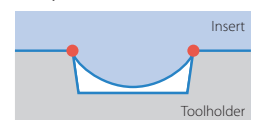

Point Contact

Cutting Edge Stability Position Comparison (Internal evaluation)

Measurement of the cutting edge position and angle after turning

Cutting Edge Movement Amount in Z Direction (mm)

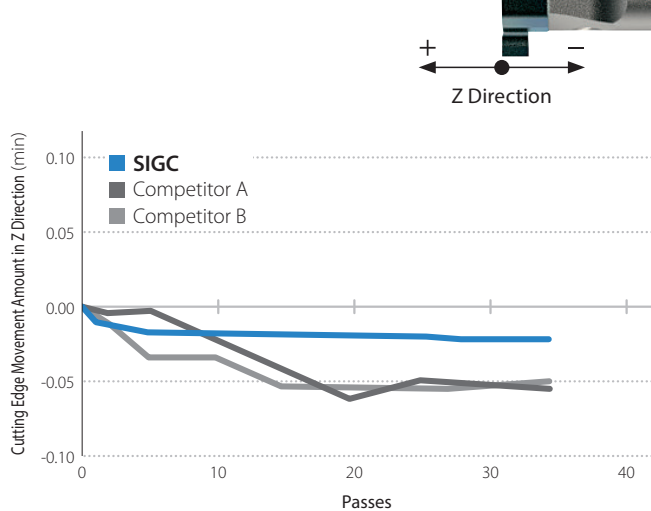

Front of Cutting Edge Angle Variation (°)

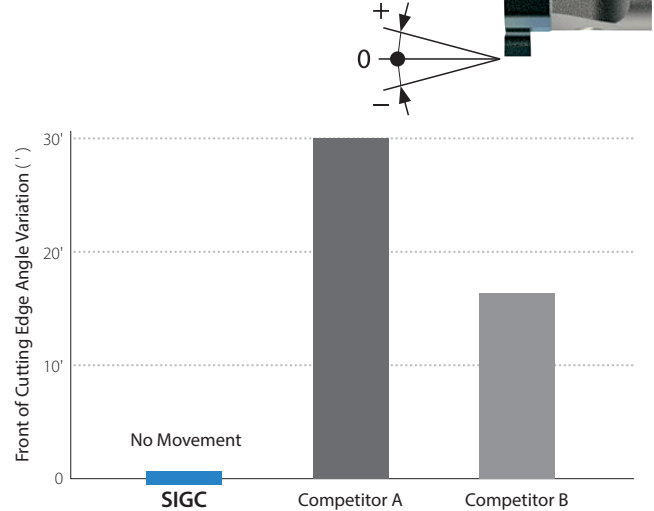

Cutting Conditions : $V_c = 50 \text{ m/min}$, $a_p = 0.2 \text{ mm}$, $f = 0.05 \text{ mm/rev}$, Wet Workpiece : SCM435 External Turning

SIGC ensures high precision machining by preventing cutting edge position movement

2 Excellent Chip Evacuation

Excellent Chip Evacuation with Double Coolant Holes and Optimized Flute Shape

Double Coolant Holes

Promotes chip evacuation by aiming at bore face of workpiece

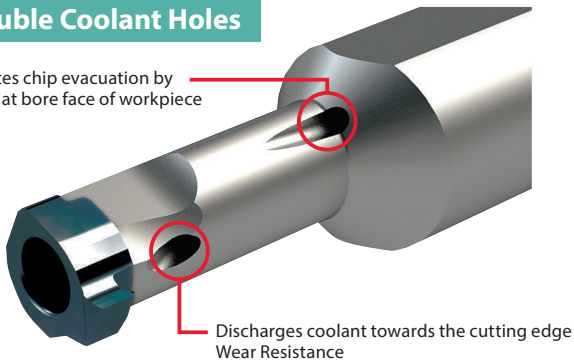

Flute Shape

Smoothly evacuates chips towards the back of the toolholder

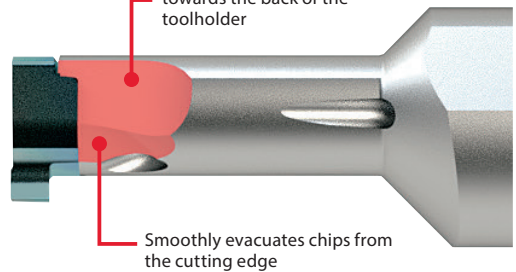

Provides a better solution when facing chip evacuation difficulties in small internal grooving
Prevents chip crunching

Chip Evacuation Comparison (Internal evaluation)

Cutting Conditions : $V_c = 50$ m/min,
 $a_p = 1.0$ mm (Shouldering), $f = 0.03$ mm/rev,
Wet (Internal Coolant), Workpiece : SCM415,
With Edge Width 2 mm

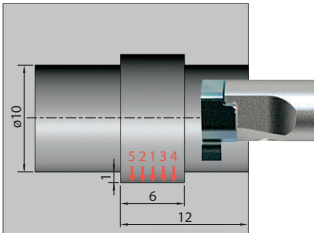

Residual Chips Rate (%)

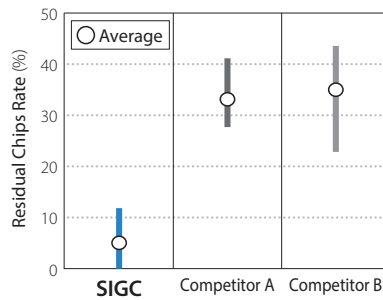

$$\text{Residual Chips Rate (\%)} = \frac{\text{Weight of remaining chip in the hole (g)}}{\text{Weight of chips removed (g)}} \times 100$$

Chip Evacuation Comparison



Good Chip Evacuation

3 Large Lineup for Various Internal Grooving

Minimum Cutting Diameter $\varnothing 8$ mm

Excellent Bars and Carbide Shank Bars Added to the Lineup

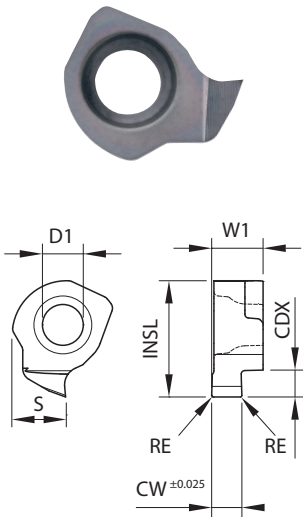

Applicable Inserts

Inserts Right-hand Insert Shown	Description	Dimension (mm)							MEGACOAT NANO PLUS		MEGACOAT NANO		Applicable Toolholders		
		CW	CDX	RE	W1	INSL	S	D1	PR1725		PR1535				
									R	L	R	L			
	GC08 R/L	100-005	1.00	1.5	0.05	3.4	7.7	3.5	2.7	●	●	●	●	SIGC R/L0812-EH SIGC R/L0806-WH	
		120-005	1.20							●	●	●	●		
		125-005	1.25							●	●	●	●		
		150-010	1.50							●	●	●	●		
		200-010	2.00							●	●	●	●		
	GC10 R/L	100-005	1.00	2.2	0.05	4.7	9.6	4.4	3.5	●	●	●	●		SIGC R/L1016-EH SIGC R/L1008-WH-L85 SIGCR1008-WH-L100
		120-005	1.20							●	●	●	●		
		125-005	1.25							●	●	●	●		
		145-010	1.45							●	●	●	●		
		150-010	1.50		0.1					●	●	●	●		
		200-010	2.00							●	●	●	●		
		250-020	2.50		0.2					●	●	●	●		
		300-020	3.00							●	●	●	●		
	GC12 R/L	100-005	1.00	2.2	0.05	4.7	11.6	5.4	3.5	●	●	●	●	SIGC R/L1216-EH SIGCR1210-WH-L95 SIGC R/L1210-WH-L110	
		120-005	1.20							●	●	●	●		
		125-005	1.25							●	●	●	●		
		145-010	1.45		0.1					●	●	●	●		
		150-010	1.50							●	●	●	●		
		200-010	2.00		0.2					●	●	●	●		
		250-020	2.50							●	●	●	●		
		300-020	3.00							●	●	●	●		

• CDX : shows available grooving depth
• Inserts are sold in 5 piece boxes

● : Standard Stock

Recommended Cutting Conditions

Workpiece	Recommended Insert Grade (Cutting Conditions Vc : m/min)		(1) f for Grooving (mm/rev)			Notes
	MEGACOAT NANO PLUS	MEGACOAT NANO	(2) f for Turning (mm/rev)			
			(3) ap for Turning (mm)			
	PR1725	PR1535	GC08 R/L...	GC10 R/L, GC12 R/L 100 ~ 200...	GC10 R/L, GC12 R/L 250 ~ 300...	
Carbon Steel (SxxC etc.)	★ 50 ~ 80	☆ 50 ~ 80	(1) 0.01 ~ 0.03	(1) 0.02 ~ 0.04	(1) 0.02 ~ 0.04	Wet
			(2) 0.01 ~ 0.03	(2) 0.02 ~ 0.04	(2) 0.02 ~ 0.04	
			(3) Max. 0.05	(3) Max. 0.05	(3) Max. 0.1	
Alloy Steel (SCM etc.)	★ 50 ~ 80	☆ 50 ~ 80	(1) 0.01 ~ 0.03	(1) 0.02 ~ 0.04	(1) 0.02 ~ 0.04	
			(2) 0.01 ~ 0.03	(2) 0.02 ~ 0.04	(2) 0.02 ~ 0.04	
			(3) Max. 0.05	(3) Max. 0.05	(3) Max. 0.1	
Stainless Steel (SUS304 etc.)	☆ 50 ~ 80	★ 50 ~ 80	(1) 0.01 ~ 0.03	(1) 0.01 ~ 0.03	(1) 0.01 ~ 0.03	
			(2) 0.01 ~ 0.03	(2) 0.01 ~ 0.03	(2) 0.01 ~ 0.03	
			(3) Max. 0.05	(3) Max. 0.05	(3) Max. 0.1	

★ : 1st Recommendation ☆ : 2nd Recommendation

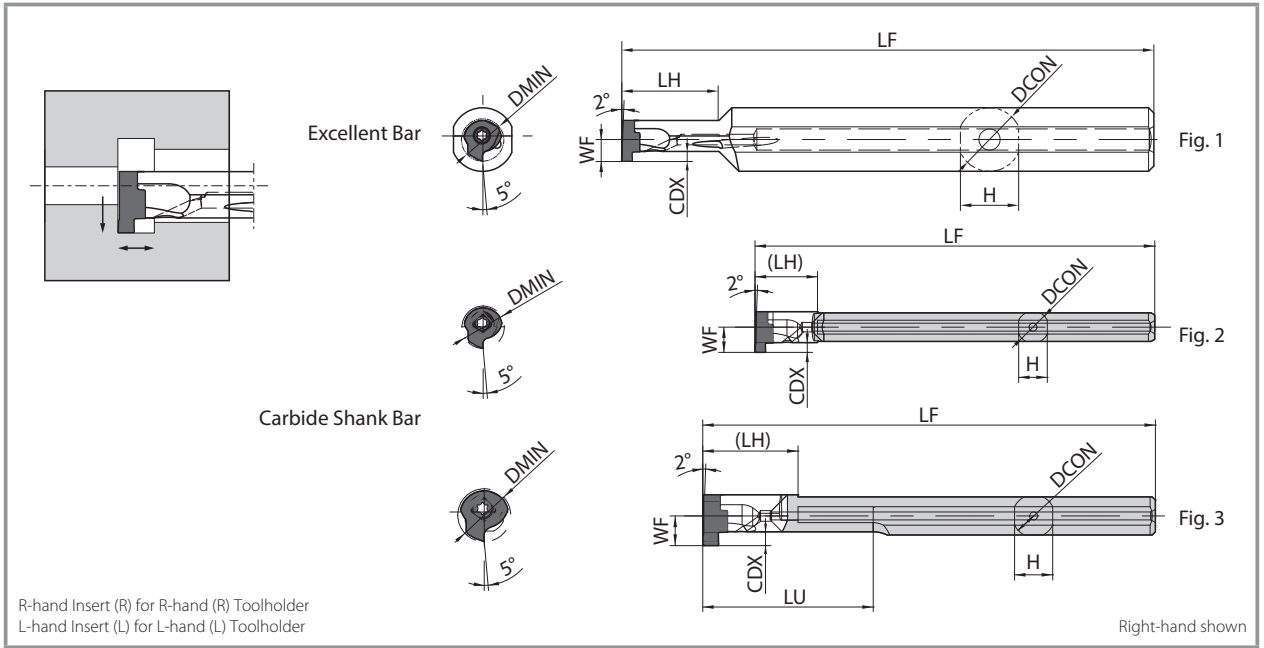

Toolholder Dimensions

Description	Stock		Min. Cutting Dia.	Dimension (mm)										Spare Parts		Applicable Insert	
	R	L		DMIN	DCON	H	LF	LU	LH	WF	CDX	Shape	Clamp Screw	Wrench			
															Icon		
SIGC R/L 0812-EH	●	●	8	12	11	100	-	18	4.1	1.5	Fig. 1	SB-2270T R/L	FT-7	GC08 R/L100-005 ~ GC08 R/L200-010			
1016-EH	●	●	10	16	15	100	-	21	5.0	2.2					SB-3070T R/L	FT-8	GC10 R/L100-005 ~ GC10 R/L300-020
1216-EH	●	●	12	16	15	110	-	25	6.0	2.2							
SIGC R/L 0806-WH	●	●	8	6	5.4	75	-	12	4.8	1.5	18	5.6	GC08 R/L100-005 ~ GC08 R/L200-010				
1008-WH-L85	●	●	10	8	7.2	85	32	6.6	2.2	GC10 R/L100-005 ~ GC10 R/L300-020							
1008-WH-L100	●	●				100	45										
1210-WH-L95	●	●	12	10	9.2	95	32	2.2	GC12R100-005 ~ GC12R300-020								
1210-WH-L110	●	●				110	45				GC12 R/L100-005 ~ GC12 R/L300-020						

Mounting Inserts

Use compressed air or other measures to remove chips from the insert pocket
 Mount the insert into the toolholder ensure the bottom makes contact with the end of the toolholder's surface
 Keeping the insert seated, tighten the insert clamp screw at an appropriate torque
 Recommended tightening torque for clamp screw : 0.8 N · m (SB-2270TR) 1.2 N · m (SB-3070TR)

L-hand clamp screw for L-hand toolholder (Fig.1)

Fig.1

GC**R-***	GC**L-***
Right-hand screw	Left-hand screw
Tool holder : SIGCR***-***	Tool holder : SIGCL***-***
Insert : GC**R-***	Insert : GC**L-***
Clamp Screw : SB-***TR	Clamp Screw : SB-***TL

Applicable Sleeve

Applicable Sleeves. Please see the KYOCERA general product catalog for more details.

Shank Size (Diameter : mm)	06 (6 mm)	08 (8 mm)	10 (10 mm)	12 (12 mm)	16 (16 mm)
Toolholders	SIGC R/L 0806-WH	SIGC R/L 1008-WH-L85 SIGC R/L 1008-WH-L100	SIGC R/L 1210-WH-L95 SIGC R/L 1210-WH-L110	SIGC R/L 0812-EH	SIGC R/L 1016-EH SIGC R/L 1216-EH
SH Sleeve (for Boring Bars)	SH 06...	SH 08...	SH 10...	SH 12...	SH 16...
SHC Sleeve (for Coolant Sleeves)	-	SHC 08...	SHC 10...	SHC 12...	SHC 16...
SHA Sleeve	-	SHA 08...	SHA 10...	SHA 12...	-
EZH Sleeve (for EZ Bars)	EZH 06...ST/CT/HP...	EZH 08...ST/CT/HP...	-	-	-

Remove the positioning pin when mounting SIGC to the EZH-CT/HP Sleeve.
 (Positioning function is not available.)

Long tool life leads to improved cycle time
Excellent surface finish with no tearing lowers quality control costs



MEGACOAT NANO PLUS

AlTiN/AlCrN Nano laminated film with superior wear resistance and adhesion resistance
Excellent Surface Finish and Long Tool Life

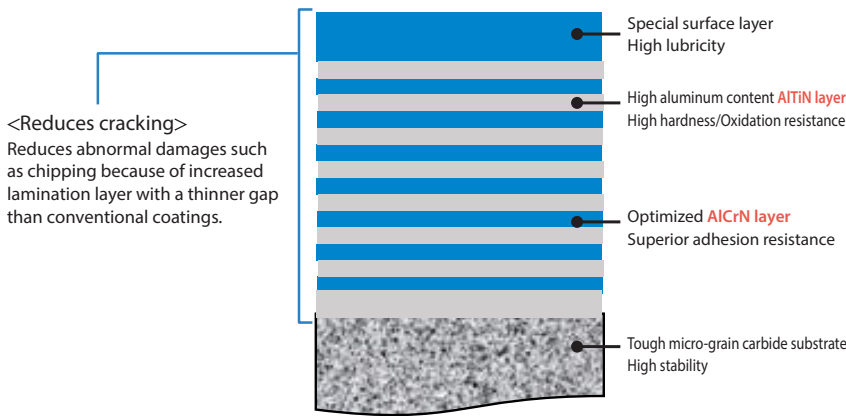

Wear Coefficient Comparison
(Internal evaluation)

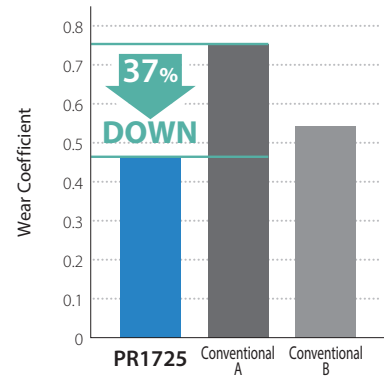

Superior Wear and Chipping Resistance

High hardness with nano laminated film layer properties
Internal stress optimization reduces chipping

Excellent Surface Finish

Special surface layer with great lubricity reduces adhesion

Applicable to Various Workpiece Materials

Excellent oxidation resistance. Superior high temperature properties maintains good performance in steel, stainless steel and free-cutting steel

High Machining Stability

Tough micro-grain carbide substrate provides stable machining